

Gallergrind

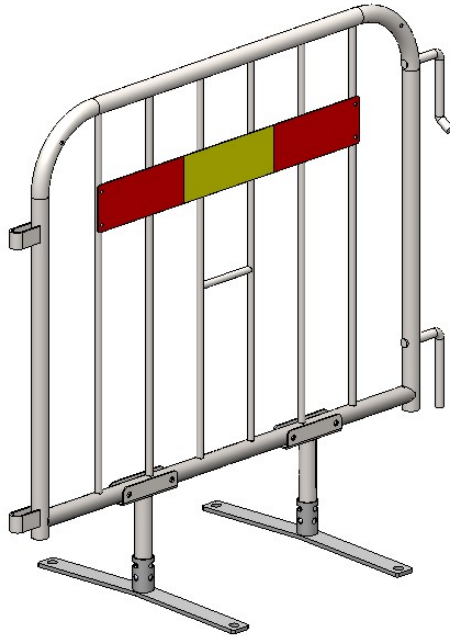

Varmförzinkad



Stål



14

[mm]

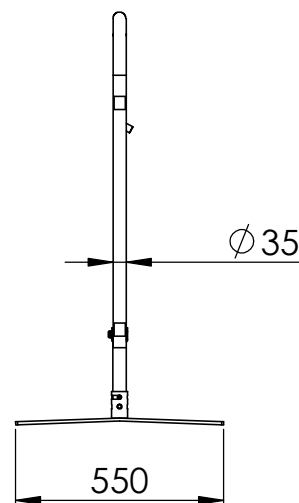
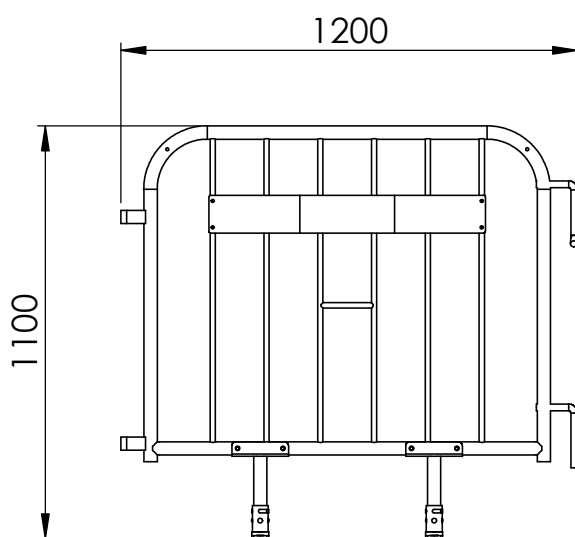

Montage

1.

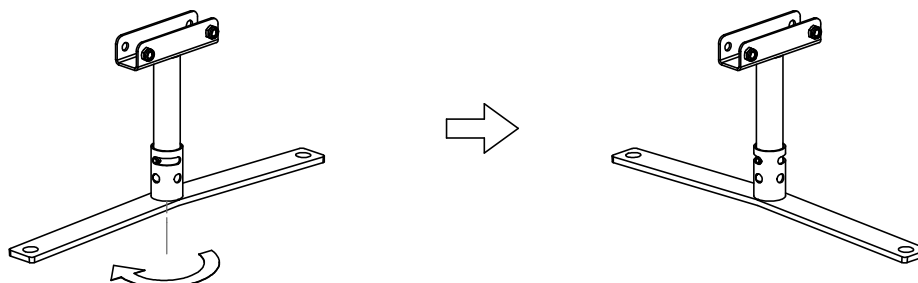

2.

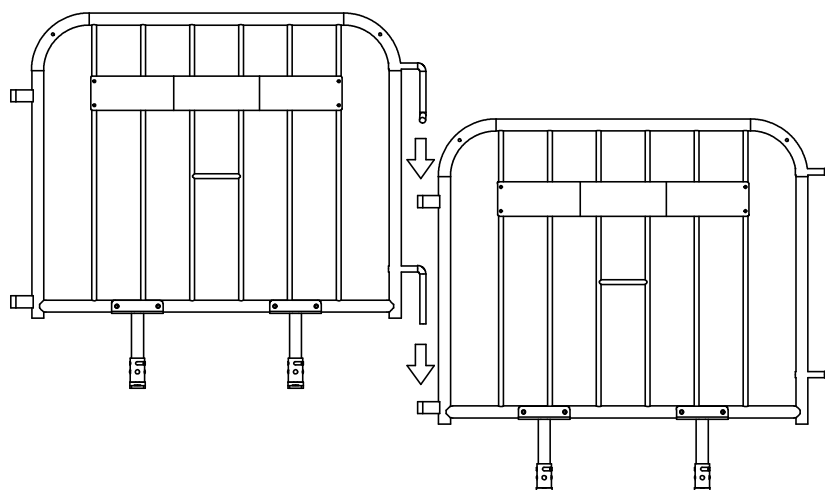

Vindlast

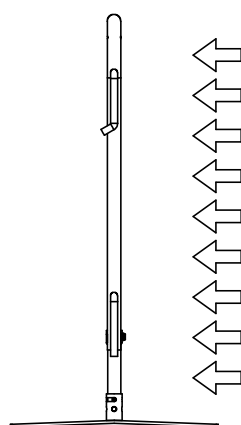

Max 15 m/s

Transport/Packning

830596

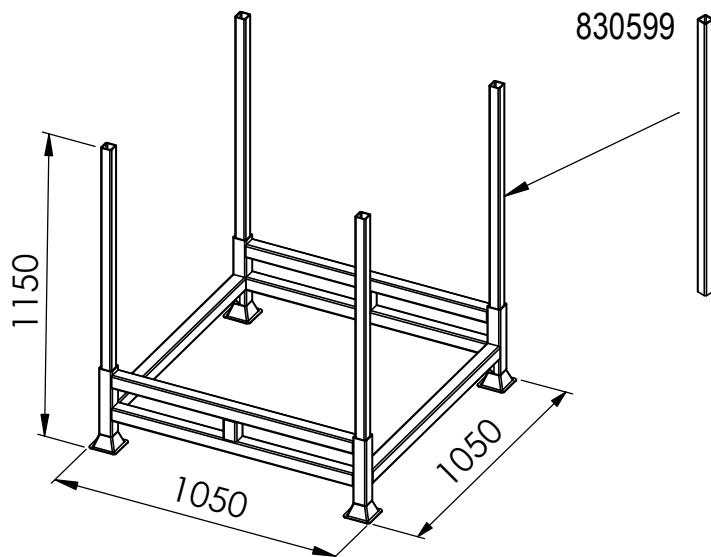

Varmförzinkad



Stål



45

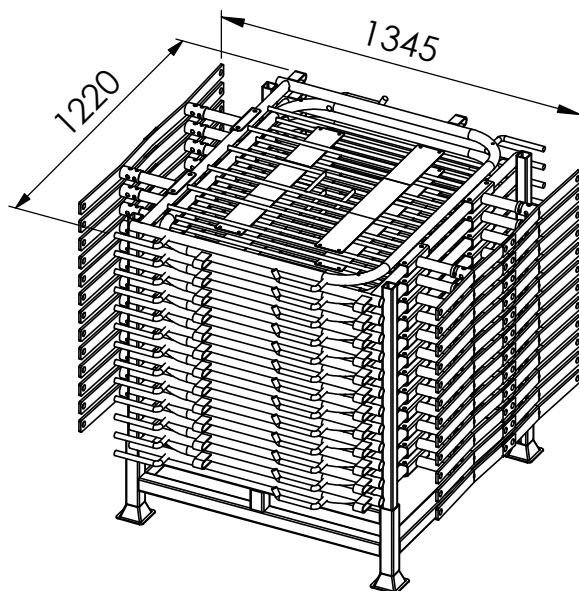

Max 25 st



395



Reservdelar

830577

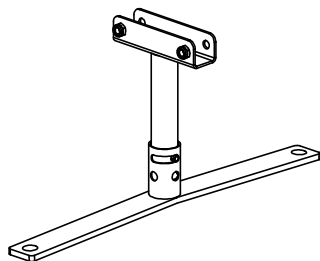

830585

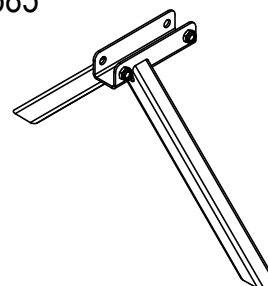

831945

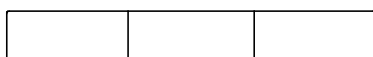

830581

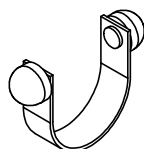

833106

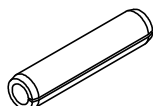















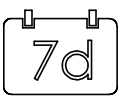

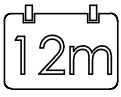
GENERELLT

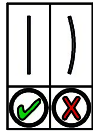
- Läs alltid igenom tillverkarens anvisningar för att säkerställa att produkten används på ett korrekt och säkert sätt.
- Vid oklarheter, kontakta tillverkaren eller aktuellt säljställe.
- Blanda aldrig produkter av olika fabrikat med varandra.
- Respektera alltid specificerade belastningsbegränsningar.

FÖRVARING

- Förvara i möjligaste mån produkterna i icke-korrosiv miljö.
- Tänk på att förvara produkterna på enligt tillverkaren avsett vis exempelvis vid stapling för att minimera risken för skador i samband med vältning eller liknande.

 Teknisk information	 Vikt	 Nm Momentdra skruvförband
 Inspektera	 Återvinning	 Lossa skruvförband
 Inspektionsintervall i dagar	 Korrekt	 Max tillåten vindhastighet
 Inspektionsintervall i månader	 Inkorrekt	 Kraft
 Kontrollera rakhet	 Se upp!	 Moment
 Kontrollera sprickbildning	 Drag åt skruvförband	 "Trä i"